

MAVIC[®]

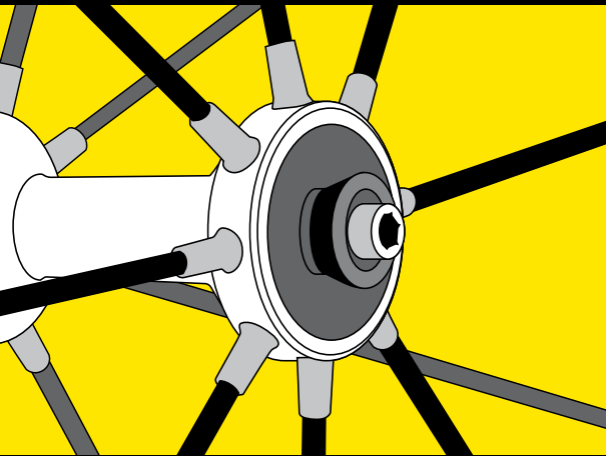

TRA
COMP

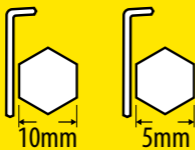
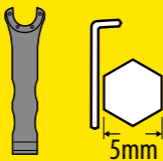

7

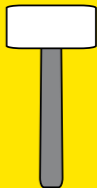
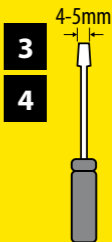
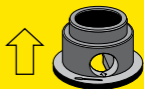
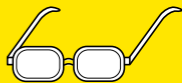

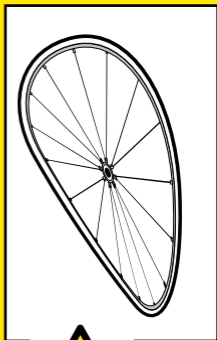
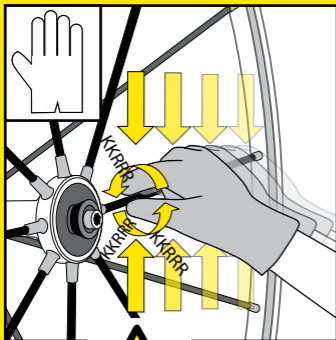

KKRRR

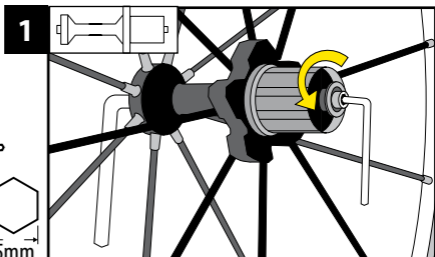
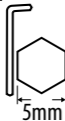
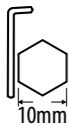

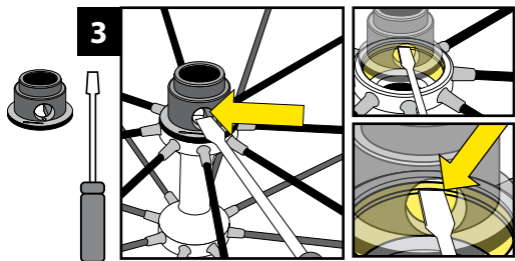
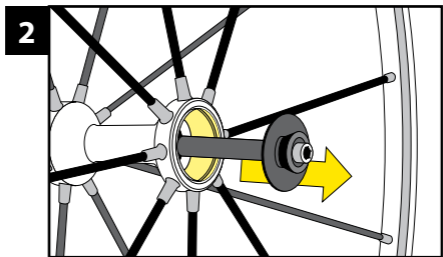
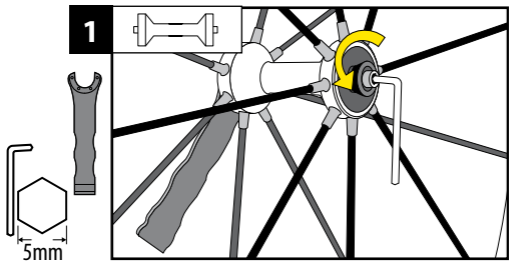

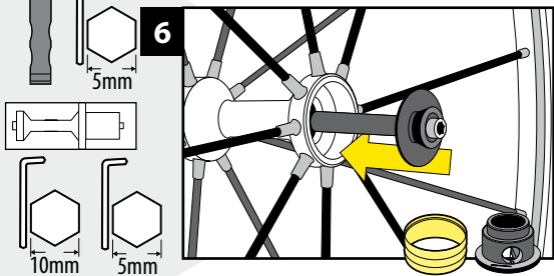
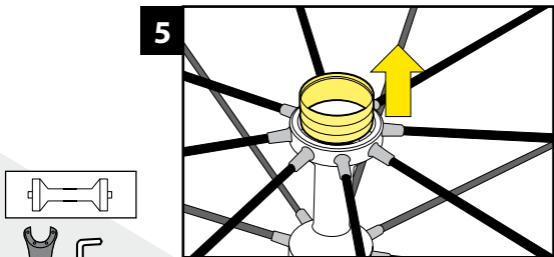
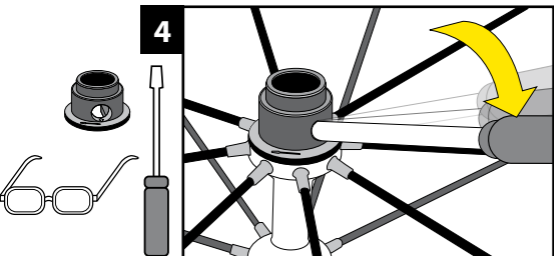

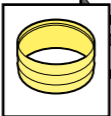
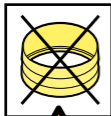
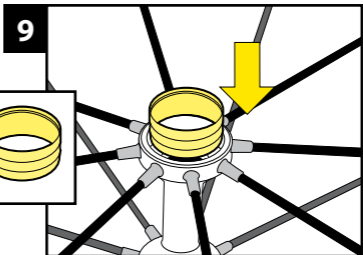
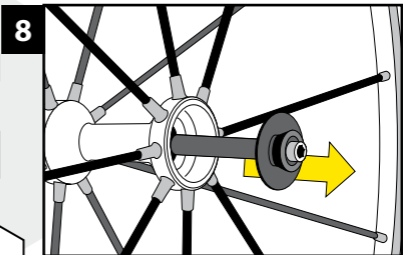
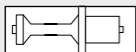
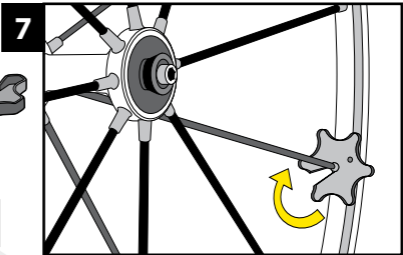

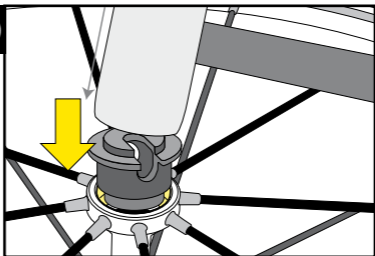
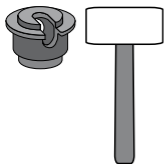
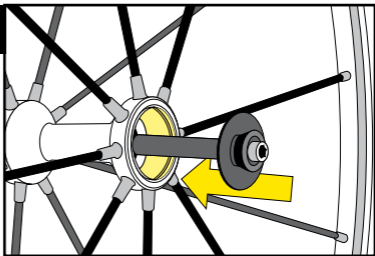
10**11**

5mm

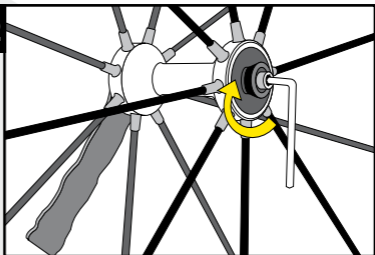
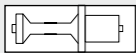
12

10mm



5mm

FR En cas de doute, consultez votre détaillant
EN In case of doubt, consult your local dealer
ALL In Zweifelsfällen bitte einen Mavic-Fachhändler kontaktieren
ESP En caso de duda consulte con su detallista
IT In caso di dubbio, consultate il vostro negoziante di fiducia
NL Raadpleeg uw locale dealer in geval van twijfel
SW Om osäker, fråga din lokala cykelhandlare
DAN I tilfælde af tvivl, kontakt din lokale forhandler
FIN Mikäli jotakin epäselvää, ota yhteyttä paikalliseen kauppiaseeseen
POL W razie wątpliwości skontaktuj się ze swoim sklepem rowerowym
TCH V případě pochybností, kontaktujte vašeho místního prodejce
JAP ご不明な点がある場合、お買い上げ頂いたマヴィック販売店にご相談ください。

FR Le non respect des procédures décrites dans ce document peut causer la casse de votre roue et entraîne la perte de la garantie Mavic
EN Not respecting the procedures described in this document may cause the breakage of a your wheel and will void the validity of the Mavic warranty
ALL Nicht-Beachten dieser Bedienungsanleitung kann zu einem Versagen (Bruch) des Laufrades führen - und bewirkt das sofortige Erlöschen der Mavic-Garantie
ESP No respetar los procedimientos descritos en este documento puede causar la rotura de su rueda, y conlleva la pérdida de la garantía Mavic
IT Il non rispetto delle procedure descritte in questo documento può causare la rottura della vostra ruota e comporta la perdita di validità della garanzia Mavic
NL Het niet respecteren van de procedures beschreven in dit document kan tot breuk van uw wiel leiden en doet de Mavic garantie vervallen
SW Efterföljs inte de rekommendationer som lämnas i dessa anvisningar kan det få till följd att hjulet skadas och Mavics garantier upphör att gälla
DAN Hvis vejledningerne i dette dokument ikke følges vil du kunne skade dit hjul og Mavic garantien vil bortfalde
FIN Tässä asiakirjassa esitettyjen ohjeiden noudattamatta jättäminen voi aiheuttaa irtopyörän rikkoutumisen ja mitätöidä Mavic takuun voimassaolon
POL Nieprzestrzeganie procedur opisanych w tym dokumencie może spowodować uszkodzenie koła i być przyczyną utraty gwarancji Mavic
TCH Nerespektování postupů popsanych v této brožurě může způsobit poškození vašeho kola a způsobí tak neplatnost záruky Mavic
JAP この文書に記載されている手順に従わなかった場合、ホイールを破損する恐れがあります。また、マヴィックの保証の対象外となります。

FR Cette notice est un complément aux autres notices Mavic
EN This user's guide is a complement to other Mavic's user's guide
ALL Diese Bedienungsanleitung ist eine Ergänzung bereits bestehender Mavic- Bedienungsanleitungen
ESP Esta guía es un complemento a los otros manuales Mavic
IT Queste istruzioni d'uso sono complementari alle altre istruzioni Mavic
NL Deze handleiding is aanvullend aan andere Mavic handleidingen
SW Denna bruksanvisning kompletterar Mavics övriga bruksanvisningar
DAN Denne brugervejledning er et supplement til andre Mavic brugervejledninger
FIN Tämä käyttöajän opas täydentää muita Mavic käyttöajän oppaita
POL Niniejsza instrukcja obsługi jest uzupełnieniem do innej instrukcji obsługi Mavic
TCH Tento průvodce je doplňkem ostatních Mavic průvodců pro uživatele
JAP このユーザーガイドは他のマヴィック取扱説明書を補足するものです。